

POVISON

# Power Reclining Sofa

INSTRUCTION MANUAL



SSF0039

## **Ergopals Power Sofa**

Marlowe is crafted in top grain leather, vintage ruffle detailing is not a gesture of fleeting romance, but an elegance shaped and tempered by time. Like a well-read book, it gains depth and presence with age.

## Installation in Just 4 Steps - Required 2 people for the assembly

1. Install the sofa legs onto the bottom of the sofa.

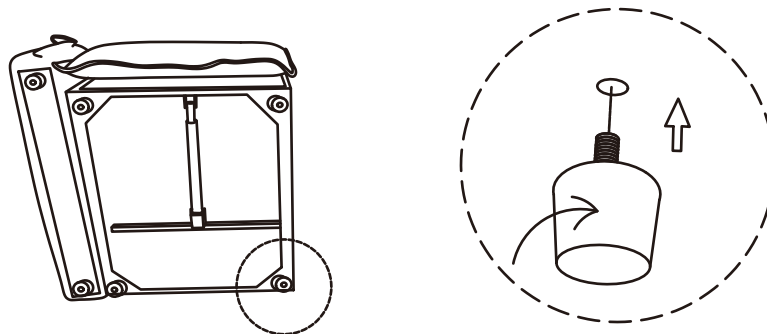

2. Assemble the main sofa sections together.

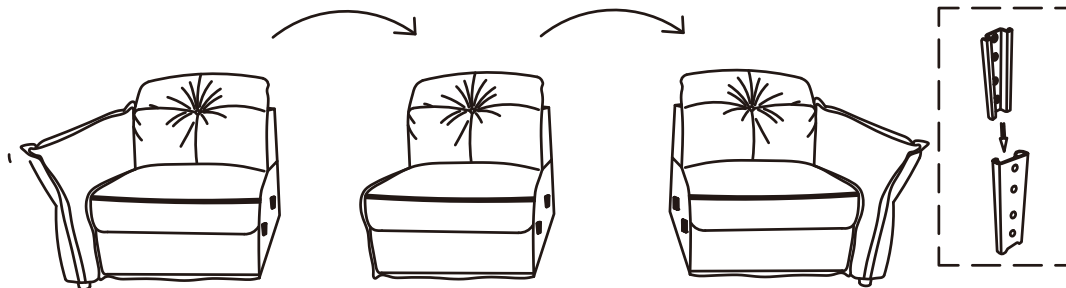



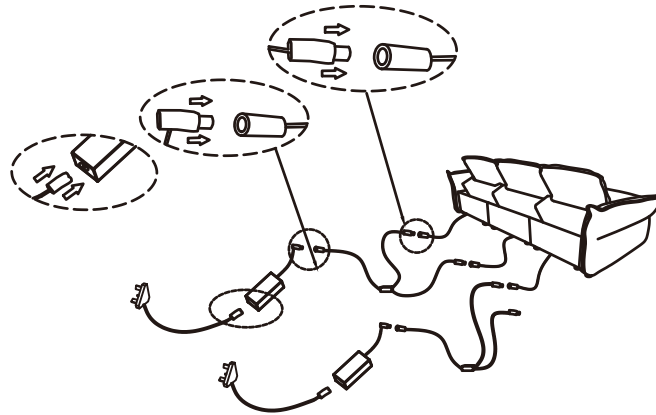

3. Connect the power supply.

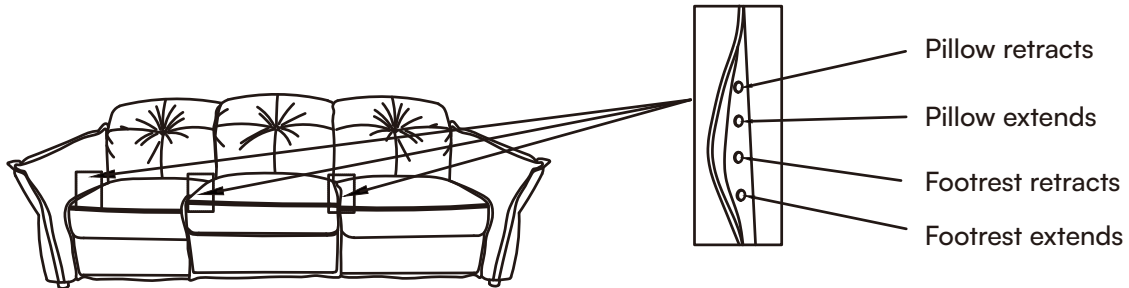

4. "The electric control buttons are located on the side of the seat cushion. Gently pull aside the leather upholstery to access them."



## Product Components Overview

Serial number	Picture	Item	QTY
A	 A line drawing of a cylindrical sofa leg with a cross-hatched top surface.	Sofa Legs	Four per seat two per armrest
B	 A line drawing of a rectangular power adapter with a two-prong electrical plug on one end and a cable on the other.	Power Adapter	One per sofa set
C	 A line drawing of a Y-splitter cable with one input end and two output ends.	Y-splitter Cable	One per sofa set
D	 A line drawing of a power cord with a three-prong electrical plug on one end and a standard cable connector on the other.	Power Cord	One per sofa set

### Notes:

1. Please take good care of this manual for your next installation.
2. Before installation, screw all the screws to 1/2 of the length installation. After all screws are half screwed in, tighten them all together.

✉ [supportingcenter@povison.com](mailto:supportingcenter@povison.com)

🌐 [www.povison.com](http://www.povison.com)

Actual product may differ. Read and retain this manual.

V1.1