

1. Store the cabinet upside down or on its side, then install the hardware table legs on the base plate (Table legs are recommended to be installed at a distance of 5cm from the cabinet)

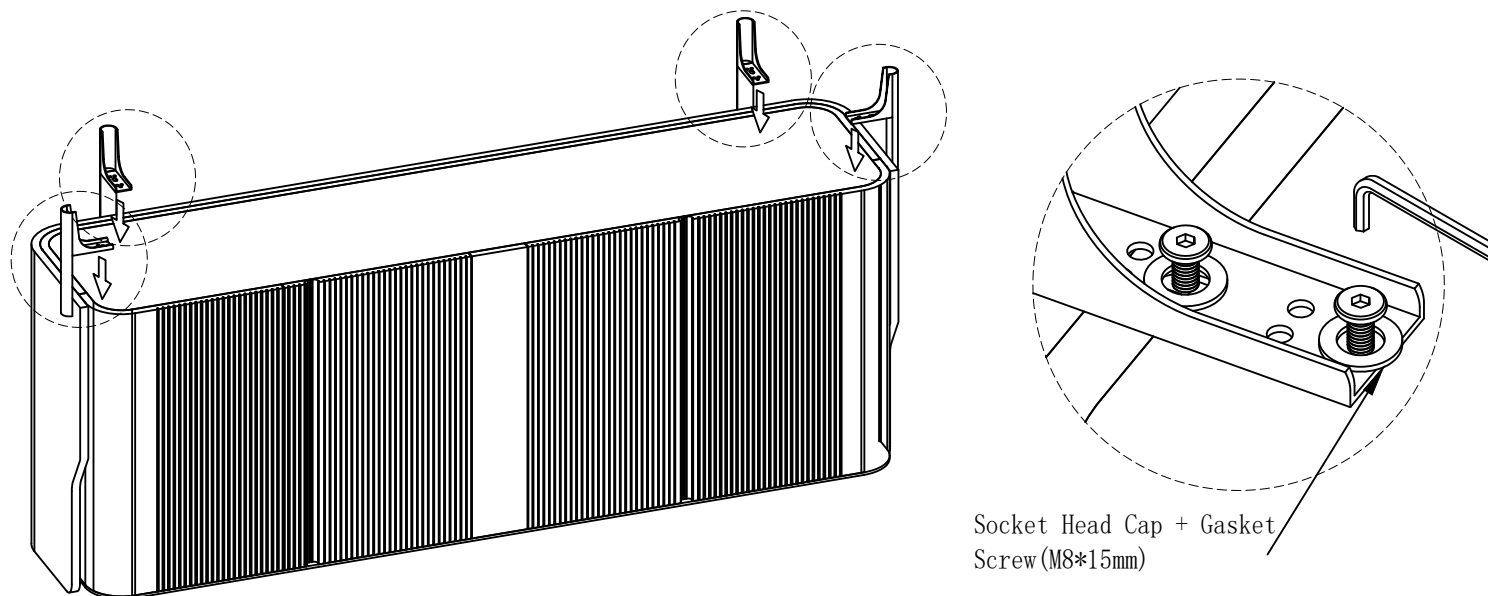

Socket Head Cap + Gasket
Screw (M8*15mm)

2. The installation is complete

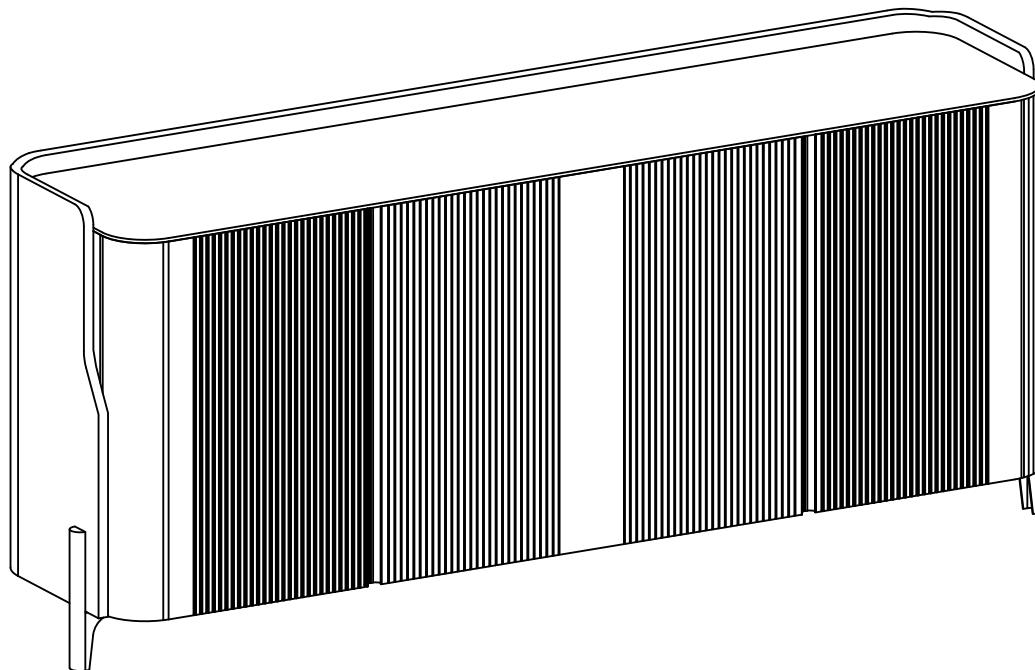



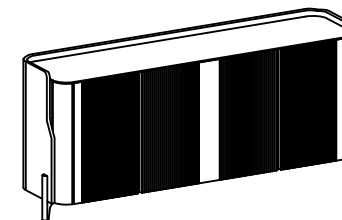

Assembly instructions



SBT0122L Installation

The number of people needed for installation: 2

- ① Please read the manual carefully before installing this product. And strictly follow the installation process
- ② Please take good care of this manual for your next installation
- ③ Note: Before installation, screw all the screws to 1/2 of the length of the installation. After all screws are half screwed in, tighten them all together.

Parts list		On a red ribbon are furniture installation accessories		
Serial number	Shape	Name	Quantity required for installation	Spare quantity
A		Socket Head Cap Screw(M8*15mm)	8	1
B		Side foot	4	0
C		Gasket	8	1
D		Wrench	1	0
E				
F				
G				